



swiss bed concept



HASENA
the dream factory



DREAM LINE

Polsterbetten | lits rembourrés | upholstered beds



Unser Versprechen

Notre promesse
Our promise



auf
**Materialbeschaffenheit,
Oberflächenbeschaffenheit und
fachgerechte Verarbeitung**

sur
la qualité des matériaux,
la finition des surfaces
et le traitement approprié

on
material quality, surface finish
and professional workmanship

Follow us:



Vielfältig in Kombination und Material

Unser ausgeklügeltes Baukastensystem «swiss bed concept» bietet eine riesige Auswahl an Füßen, Kopfteilen und Beimöbeln. Darüber hinaus umfasst unser Sortiment verschiedene Stoff-, Kunstleder- und Lederbezüge sowie diverse Holz- und Metallausführungen. Abgestimmte Lattenroste und Matratzen komplettieren die Hasena-Betten zum Wohlfühl-Raum. Modelländerungen sind vorbehalten.

Combinaisons et matières variées

Notre système modulaire sophistiqué "swiss bed concept" propose un choix énorme de pieds, têtes de lits et accessoires. Par ailleurs notre assortiment comporte différents tissus, cuirs synthétiques et véritables, ainsi que diverses variantes de bois et métal. Des sommiers à lattes et des matelas adaptés complètent les lits Hasena pour un espace bien-être. Des modifications de modèles restent réservées.

Versatile in combination and material

Our ingenious modular system "swiss bed concept" offers a huge selection of feet, headboards and accessories. In addition, our product range includes different fabrics, synthetic leather and real leather covers and different wood and metal versions. Matching slatted frames and mattresses complete the Hasena beds to a feel-good space. The right is reserved to changes in model.



Stabil im Aufbau

Unsere Betten überzeugen durch eine hohe Stabilität. Mittels Einsatz verschiedener Traversen ist eine gesamthafte Belastung von 300 bis 450 kg, inklusive Lattenroste und Matratzen, möglich.

Construction robuste

Nos lits sont convainçants par leur grande stabilité. En utilisant différentes fermes, une charge totale de 300 à 450 kg, y compris les sommiers à lattes et les matelas, est possible.

Solid in construction

Our beds convince with their high stability. By using different trusses, a total load of 300 to 450 kg, including slatted frames and mattresses, is possible.



Einfach in der Montage

Unser Betten-System begeistert durch einen einfachen Aufbau mit leicht verständlicher Montageanleitung sowie hochwertigen Verbindungselementen, welche einen vielfachen Ab- und Wiederaufbau ermöglichen.

Montage facile

Notre système de lits séduit par une installation facile grâce aux instructions de montage bien compréhensibles ainsi que par les éléments de fixation haut de gamme permettant de monter et démonter les lits à de nombreuses reprises.

Solid in construction

Our beds convince with their high stability. By using different trusses, a total load of 300 to 450 kg, including slatted frames and mattresses, is possible.



swiss bed concept



www.hasena.ch

Unsere Qualität

Dank swiss bed concept sind Ihrer Kreativität kaum Grenzen gesetzt. Sie wählen Ihr favorisiertes Unter-gestell aus und kombinieren dazu Füße, Kopfteil, Matratze und Topper Ihrer Wahl. Dabei können Sie quer durch die Kollektionen auf unterschiedliche Materialien und Farben zugreifen.

Un système modulaire intelligent

Grâce au swiss bed concept, votre créativité n'a pratiquement pas de limites. Vous choisissez votre sommier préféré et vous combinez avec les pieds, la tête de lit, matelas et surmatelas de votre choix. En l'occurrence, vous pouvez piocher différents matériaux et couleurs dans toutes les collections.

A clever modular system

Thanks to swiss bed concept, there are virtually no limits to your creativity. You choose your favourite mattress base, and combine it with legs, headboard, mattress and topper of your choice. Go through all our collections to find the various materials and colours..

Nachhaltigkeit bei Hasena

le développement durable chez Hasena | sustainability at Hasena

Unser wichtigster Lieferant, die Natur, ist sensibel und benötigt lange Regenerationszeiten bei Überbeanspruchung. Wir respektieren die von uns genutzten Ökosysteme und stellen unsere Produkte nachhaltig und mit hohem sozialen Engagement her. Denn nicht nur die Beschaffung des Holzes aus nachweislich verantwortungsvoll bewirtschafteten Wäldern ist für die Erhaltung einer gesunden Natur relevant. Auch der langfristig ausgerichtete soziale Umgang mit Mitarbeitern und Partnern stärkt den schonungsvollen Umgang mit der gesamten Umwelt.

Notre fournisseur le plus important, la nature, est sensible et nécessite un long temps de régénération en cas de surutilisation. Nous respectons les écosystèmes que nous utilisons et fabriquons nos produits de manière durable et avec un haut niveau d'engagement social. En effet, l'approvisionnement en bois provenant de forêts gérées de manière responsable n'est pas le seul élément pertinent pour la préservation d'une nature saine. L'interaction sociale à long terme avec les employés et les partenaires renforce également le respect de l'ensemble de l'environnement.

Our most important supplier, nature, is sensitive and needs long regeneration times in case of overuse. We respect the ecosystems we use and manufacture our products sustainably and with a high level of social commitment. Because it is not only the purchasing of wood from demonstrably responsibly managed forests that is relevant for the preservation of a healthy nature. The long-term social interaction with employees and partners also strengthens the careful treatment of the entire environment.

Soziale Verantwortung

Responsabilité sociale
Social responsibility



Holzbeschaffung

Approvisionnement en bois
Wood procurement

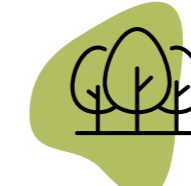

Energiegewinnung

Production énergétique
Production of energy



Wärmegewinnung

Production thermique
Production of heat



Weitere Modelle und Kombinationsmöglichkeiten finden Sie auf unserer Webseite. | Des modifications de modèles restent réservées. Vous trouverez d'autres modèles et combinaisons possibles sur notre site Internet. | The right is reserved to changes in model. Further models and possible combinations can be found on our website.

Weitere Infos zur Nachhaltigkeit bei Hasena finden Sie auf unserer Webseite. | Vous trouverez plus d'informations sur la durabilité chez Hasena sur notre site Internet. | Further informations about sustainability at Hasena can be found on our website.

3. Preiskategorie | 3^e catégorie de prix | 3rd price range

Alpina 390–394, 100% Polyester



390 lightgrey 391 anthrazit 392 red 393 navy 394 smoke

Boston 650–654, Oberfläche | surface: 100% Polyester, Basis | base: 70% Polyester, 30% Baumwolle | coton | cotton



650 clay 651 bean 652 mocca 653 turtle 654 tizo

Campos 372–376, Kunstleder | cuir synthétique | synthetic leather

Oberfläche | surface: 100% Polyurethan | polyurethane, Basis | base: 71% Polyester, 29% Baumwolle | coton | cotton



372 blanc 373 creme 374 cafe 375 nero 376 kit

Casual 330–334, Kunstleder | cuir synthétique | synthetic leather

Oberfläche | surface: 100% Polyurethan | polyurethane, Basis | base: 60% Polyester, 40% Baumwolle | coton | cotton



330 sahara 331 cannelle 332 cognac 333 olive 334 carbon

Kabo 630–634, 100% Polyester



630 calc 631 rust 632 apple 633 lagoon 634 belle

Kitana 600–604, 100% Polyester



600 beige 601 nougat 602 grigio 603 aqua 604 anthrazit

Prisma 670–674, 100% Polyester

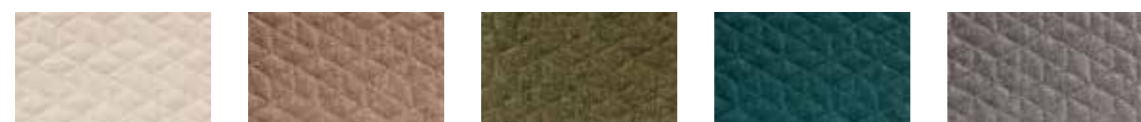

670 polar 671 zircon 672 jade 673 smaragd 674 silver

Ranch 660–664, 100% Baumwolle | coton | cotton



660 stone 661 grit 662 jeans 663 indigo 664 hunter

Shine 680–685, 100% Polyester



680 wine 681 rose 682 opal 683 musk 684 curry 685 stone

4. Preiskategorie | 4^e catégorie de prix | 4th price range

Real* 505–516, Echtleder | cuir véritable | real leather



505 bianco 506 ecru 507 creta 508 moro 509 ardesia



513 falda 514 cenere 515 panna 516 notte

Boston, Kabo, Prisma, Alpina, Kitana und Ranch können chemisch gereinigt werden. Die abgebildeten Farben können von den Originalfarben und Strukturen abweichen.

*Narben, Farb- und Strukturdifferenzen sowie Faltenbildung sind Natureigenschaften von echtem Leder. Leder enthält nichttextile Teile tierischen Ursprungs.

Nous conseillons un nettoyage à sec pour les matières Boston, Kabo, Prisma, Alpina, Kitana et Ranch. Les couleurs et les structures des illustrations peuvent être différentes des couleurs et des structures originales.

*Les cicatrices, les différences de teinte et de structure ainsi que la formation de plis sont des marques naturelles du cuir véritable. Le cuir contient des éléments non textiles d'origine animale.

The covers Boston, Kabo, Prisma, Alpina, Kitana and Ranch can be dry cleaned. The pictured colours can be different than the original colours and structures.

*Any marks, differences of colour or structure or wrinkle formations are natural characteristics of real leather. Leather includes non-textile parts of animal origin.

Beimöbel für die unbegrenzte Gestaltung

Des accessoires pour un design illimité

Accessories for the unlimited design



Ciara 23/4S

Dimension
90, 100, 120, 140, 160, 180, 200
× 200, 210, 220 cm

Kopfteil **Ripo**
Füsse **Arc** 20, 25 cm
Nachttisch **Primea** Schublade Tip-on, 50/40/59
Bank **Sola** 140/37/38

Alle Polsterteile in Kitana grigio 602
Alle Holzteile in Eiche bianco, geölt

tête de lit **Ripo**
pieds **Arc** 20, 25 cm
table de nuit **Primea** tiroir Tip-on, 50/40/59
banquette **Sola** 140/37/38

toutes les parties rembourrées en Kitana grigio 602
toutes les parties en bois en chêne bianco, huilé

headboard **Ripo**
feet **Arc** 20, 25 cm
bedside table **Primea** drawer Tip-on, 50/40/59
bench **Sola** 140/37/38

all upholstery parts in Kitana grigio 602
all wooden parts in oak bianco, oiled



Ciara 28/3S

Dimension: 140, 160, 180, 200
× 200, 210, 220 cm

Kopfteil **Julia**

Füße **Tondo** 20 cm anthracit
Nachttische **Nali** Ø 48/52, anthracit
Bank **Topa** 144/44/38, anthracit
Garderobenmöbel **Atrio** anthracit 110/54/119
Kommode **Tola** 50/49/97

Alle Polsterteile in Boston turtle 653
Alle Holzteile in Eiche bianco, geölt

tête de lit **Julia**

pieds **Tondo** 20 cm anthracit
table de nuit **Nali** Ø 48/52, anthracit
banquette **Topa** 144/44/38, anthracit
meuble de penderie **Atrio** anthracit 110/54/119
commode **Tola** 50/49/97

toutes les parties rembourrées en Boston turtle 653
toutes les parties en bois en chêne bianco, huilé

headboard **Julia**

feet **Tondo** 20 cm anthracit
bedside table **Nali** Ø 48/52, anthracit
bench **Topa** 144/44/38, anthracit
wardrobe furniture **Atrio** anthracit 110/54/119
chest od drawers **Tola** 50/49/97

all upholstery parts in Boston turtle 653
all wooden parts in oak bianco, oiled



Moon 18/3S

Dimension
140, 160, 180, 200
× 200, 210, 220 cm

Kopfteil **Orion**

Kufen **Slid** anthracit, 20, 25 cm
Nachtisch **Lina** anthracit, Ø 45/52
Garderobemöbel **Atrium** anthracit, 110/54/119

Alle Polsterteile in Prisma smaragd 673
Alle Holzteile in Nussbaum, geölt

tête de lit **Orion**

patins **Slid** anthracit, 20, 25 cm
table de nuit **Lina** anthracit, Ø 45/52
meuble de penderie **Atrium** anthracit, 110/54/119

toutes les parties rembourrées en Prisma smaragd 673
toutes les parties en bois en noyer, huilé

headboard **Orion**

vats **Slid** anthracit, 20, 25 cm
bedside table **Lina** anthracit, Ø 45/52
wardrobe furniture **Atrium** anthracit, 110/54/119

all upholstery parts in Prisma smaragd 673
all wooden parts in walnut, oiled





Moon 18/4S

Dimension: 140, 160, 180, 200
× 200, 210, 220 cm

Kopfteil **Talma**

Füße **Tondo** 20 cm anthracit
Nachtische **Nali** Ø 48/52, anthracit
Bank **Topa** 144/44/38, anthracit

Alle Polsterteile in Shine curry 684
Alle Holzteile in Nussbaum, geölt

tête de lit **Talma**

pieds **Tondo** 20 cm anthracit
table de nuit **Nali** Ø 48/52, anthracit
banquette **Topa** 144/44/38, anthracit

toutes les parties rembourrées en Shine curry 684
toutes les parties en bois en noyer, huilé

headboard **Talma**

feet **Tondo** 20 cm anthracit
bedside table **Nali** Ø 48/52, anthracit
bench **Topa** 144/44/38, anthracit

all upholstery parts in Shine curry 684
all wooden parts in alnut, oiled

Sole 18/3S

Dimension
140, 160, 180, 200
× 200, 210, 220 cm

Kopfteil **Siena**

Kufen **Slid** anthracit, 20, 25 cm
Nachtisch **Lina** anthracit, Ø 45/52
Lampen (2er Set) **Snake** alu

Alle Polsterteile in Boston bean 651
Alle Holzteile in Eiche bianco, geölt

tête de lit **Siena**

patins **Slid** anthracit, 20, 25 cm
table de nuit **Lina** anthracit, Ø 45/52
lampes (set de 2) **Snake** alu

toutes les parties rembourrées en Boston bean 651
toutes les parties en bois en chêne bianco, huilé

headboard **Siena**

vats **Slid** anthracit, 20, 25 cm
bedside table **Lina** anthracit, Ø 45/52
lamps (set of 2) **Snake** alu

all upholstery parts in Boston bean 651
all wooden parts in oak bianco, oiled



Sole 18/4S

Dimension: 140, 160, 180, 200
× 200, 210, 220 cm

Kopfteil **Cussina**

Füße **Fasio** 20 cm, bronze

Nachttische **Nali** Ø 48/52, bronze

Kommode **Tola** 50/49/97, Griffe (5er-Set) **Rivo** bronze

Alle Polsterteile in Shine wine 680

Alle Holzteile in Eiche bianco, geölt

tête de lit **Cussina**

pieds **Fasio** 20 cm bronze

table de nuit **Nali** Ø 48/52, bronze

commode **Tola** 50/49/97, poignées (set de 5) **Rivo** bronze

toutes les parties rembourrées en Shine wine 680

toutes les parties en bois en chêne bianco, huilé

headboard **Cussina**

feet **Fasio** 20 cm bronze

bedside table **Nali** Ø 48/52, bronze

chest of drawers **Tola** 50/49/97, handles (set of 5) **Rivo** bronze

all upholstery parts in Shine wine 680

all wooden parts in oak bianco, oiled



Lungo 23/2S

Dimension

90, 100, 120, 140, 160, 180, 200
× 200, 210, 220 cm

Kopfteil/Fussteil **Venus**

Kufen **Slid** anthracit, 20, 25 cm

Nachttisch **Modo** 50/49/51 + Füße **Jone** anthracit

Kommode **Tola** 50/49/97

Lampen (2er Set) **Smart** black + **Combino**

Alle Polsterteile in Casual Carbon 334

Alle Holzteile in Eiche bianco, geölt

tête de lit/pied de lit **Venus**

patins **Slid** anthracit, 20, 25 cm

table de nuit **Modo** 50/49/51 + pieds **Jone** anthracit

commode **Tola** 50/49/97

lampes (set de 2) **Smart** black + **Combino**

toutes les parties rembourrées en Casual Carbon 334

toutes les parties en bois en chêne bianco, huilé

headboard/footboard **Venus**

vats **Slid** anthracit, 20, 25 cm

bedside table **Modo** 50/49/51 + feet **Jone** anthracit

chest of drawers **Tola** 50/49/51

lamps (set of 2) **Smart** black + **Combino**

all upholstery parts in Casual Carbon 334

all wooden parts in oak bianco, oiled



Lungo 23/2S

Dimension 140, 160, 180, 200
× 200, 210, 220 cm

Kopfteil/Fussteil **Combia**
Füsse **Fasio** bronze, 20 cm
Nachtisch **Lina** Ø 45/52, bronze

Alle Polsterteile in Shine musk 683
Alle Holzteile in Nussbaum, geölt

tête de lit/pied de lit **Combia**
pieds **Fasio** bronze, 20 cm
table de nuit **Lina** Ø 45/52, bronze

toutes les parties rembourrées en Shine musk 683
toutes les parties en bois en noyer, huilé

headboard/footboard **Combia**
feet **Fasio** bronze, 20 cm
bedside table **Lina** Ø 45/52, bronze

all upholstery parts in Shine musk 683
all wooden parts in oak walnut, oiled



Lungo 23/3S

Dimension
140, 160, 180, 200
× 200, 210, 220 cm

Kopfteil **Zuro M**

Füsse **Jeno** anthracit, 10, 20, 25 cm
Nachtisch **Modo** 50/49/51 + Füsse **Jone** anthracit
Nachtisch/Hocker **Tree** Ø 42/44
Sekretär **Scola** 120/70/72-88
Bank **Banco** 140/37/35 + Kissen **Vano**

Alle Polsterteile in Echtleder Real falda 513
Alle Holzteile in Akazie Vintage grey

tête de lit **Zuro M**

pieds **Jeno** anthracit, 10, 20, 25 cm
table de nuit **Modo** 50/49/51 + pieds **Jone** anthracit
table de nuit/tabouret **Tree** Ø 42/44
secrétaire **Scola** 120/70/72-88
banquette **Banco** 140/37/35 + cussin **Vano**

toutes les parties rembourrées en cuir véritable Real falda 513
toutes les parties en bois en acacia Vintage grey

headboard **Zuro M**

feet **Jeno** anthracit, 10, 20, 25 cm
bedside table **Modo** 50/49/51 + feet **Jone** anthracit
bedside table/stool **Tree** Ø 42/44
bureau **Scola** 120/70/72-88
bench **Banco** 140/37/35 + cushion **Vano**

all upholstery parts in real leather Real falda 513
all wooden parts in acacia Vintage grey



Ciara 23/4S

Dimension
140, 160, 180, 200
× 200, 210, 220 cm

Kopfteil **Suno**
Kufen **Slid** white, 20, 25 cm
Nachttisch **Sica** 50/44/47 + Füße **Jone 10** white
Garderobenmöbel **Atrium** 110/54/119, anthracit
Lampen (2er Set) **Smart** white

Alle Polsterteile in Campos blanc 372
Alle Holzteile in Buche weiss deckend, lackiert

tête de lit **Suno**
patins **Slid** white, 20, 25 cm
table de nuit **Sica** 50/44/47 + pieds **Jone 10** white
meuble de penderie **Atrium** 110/54/119, anthracit
lampes (set de 2) **Smart** white

toutes les parties rembourrées en Campos blanc 372
toutes les parties en bois en hêtre blanc couvrant

headboard **Suno**
vats **Slid** white, 20, 25 cm
bedside table **Sica** 50/44/47 + feet **Jone 10** white
wardrobe furniture **Atrium** 110/54/119, anthracit
lamps (set of 2) **Smart** white

all upholstery parts in Campos blanc 372
all wooden parts in beech white covered, lacquered



Ciara 28/3S

Dimension
140, 160, 180, 200
× 200, 210, 220 cm

Kopfteil **Kimo**

Füsse **Masi** 10, 20, 25 cm

Nachttisch **Noma** 48/43/47 + Füsse **Sima** 10

Kommode **Sigma** 120/49/76 + Füsse **Sima** 10

Bank **Sola** 140/37/38

Alle Polsterteile in Kabo belle 634

Alle Holzteile in Eiche bianco, gebürstet, geölt

tête de lit **Kimo**

pieds **Masi** 10, 20, 25 cm

table de nuit **Noma** 48/43/47 + pieds **Sima** 10

commode **Sigma** 120/49/76 + pieds **Sima** 10

banquette **Sola** 140/37/38

toutes les parties rembourrées en Kabo belle 634

toutes les parties en bois en chêne bianco, brossé, huilé

headboard **Kimo**

feet **Masi** 10, 20, 25 cm

bedside table **Noma** 48/43/47 + feet **Sima** 10

Kommode **Sigma** 120/49/76 + feet **Sima** 10

bench **Sola** 140/37/38

all upholstery parts in Kabo belle 634

all wooden parts in oak bianco, brushed, oiled



Ciara 28/3S

Dimension
140, 160, 180, 200
× 200, 210, 220 cm

Kopfteil **Damo**
Füsse **Ivivo** 10, 20, 25 cm

Alle Polsterteile in Casual olive 333
Alle Holzteile in Nussbaum geölt

tête de lit **Damo**
pieds **Ivivo** 10, 20, 25 cm

toutes les parties rembourrées en Casual olive 333
toutes les parties en bois en noyer huilé

headboard **Damo**
feet **Ivivo** 10, 20, 25 cm

all upholstery parts in Casual olive 333
all wooden parts in walnut oiled



Ciara 28/4S

Dimension
90, 100, 120, 140, 160, 180, 200
× 200, 210, 220 cm

Kopfteil **Obag**
Füsse **Masi** 10, 20, 25 cm
Nachttisch **Trigo** 48/43/55
Nachttisch/Hocker **Circo 44** Ø 45/44
Sekretär **Aska** 120/60/85

Alle Polsterteile in Campos blanc 372
Alle Holzteile in Nussbaum, geölt

tête de lit **Obag**
pieds **Masi** 10, 20, 25 cm
table de nuit **Trigo** 48/43/55
table de nuit/tabouret **Circo 44** Ø 45/44
secrétaire **Aska** 120/60/85

toutes les parties rembourrées en Campos blanc 372
toutes les parties en bois en noyer, huilé

headboard **Obag**
feet **Masi** 10, 20, 25 cm
bedside table **Trigo** 48/43/47
bedside table/stool **Circo 44** Ø 45/44
bureau **Aska** 120/60/85

all upholstery parts in Campos blanc 372
all wooden parts in walnut, oiled





Silenzio

Bett | lit | bed

Silenzio 23



Silenzio 28



Stoffauswahl siehe Seiten 11.16/17 | Choix de tissus voir pages 11.16/17 | Choice of tissues see pages 11.16/17

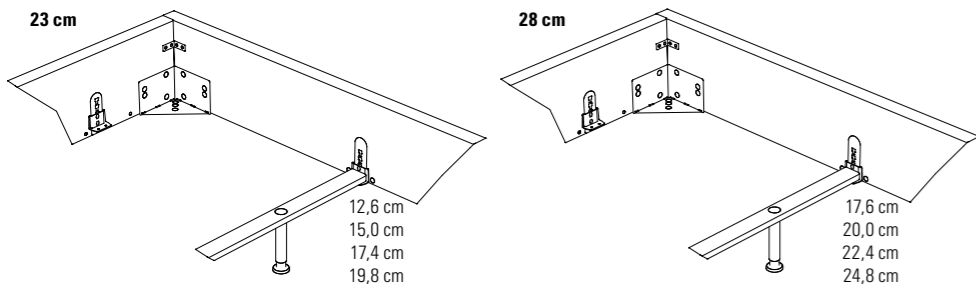

Bei allen Betten Silenzio 23/28 ist die Einlegetiefe in 4 verschiedenen Höhen standardmässig verstellbar.
 Midtraver-move ist bei allen Betten Silenzio 23/28 ab der Breite 160 cm inklusive.

Tous les lits Silenzio 23/28 ont une profondeur d'insertion réglable de 4 hauteurs différentes en standard.
 Midtraver-move est inclus avec tous les lits Silenzio 23/28 à partir de 160 cm de largeur.

All Silenzio 23/28 beds have an adjustable insertion depth of 4 different heights as standard.
 Midtraver-move is included with all Silenzio 23/28 beds from 160 cm width.

Ausführungen | exécutions | executions

Holz | bois | wood



71
Eiche bianco, geölt
 Chêne bianco, huilé
 Oak bianco, oiled

85
Nussbaum, geölt
 Noyer, huilé
 Walnut, oiled

Weitere Beimöbel siehe Register 2 | autres accessoires voir registre 2 | further accessories see index 2



Kopfteile | têtes de lit | headboards

Suno

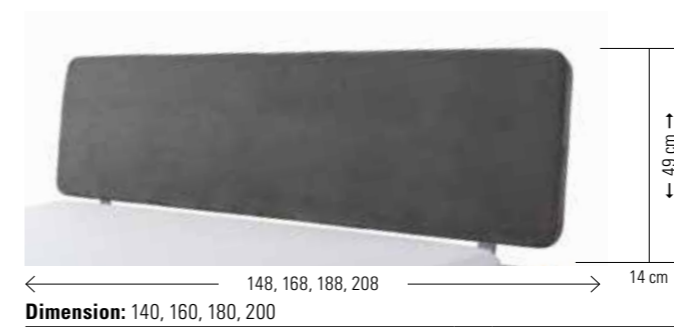

Ripo

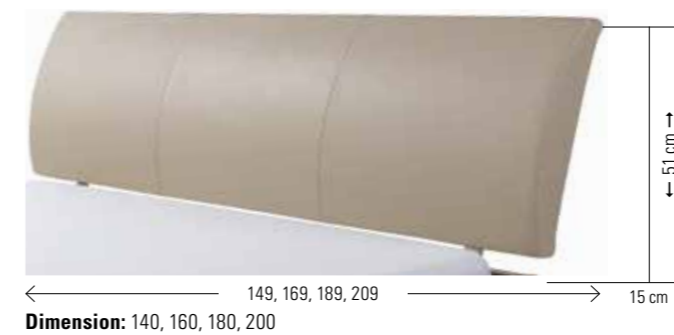

*Lampen nicht montierbar | montage de lampes impossible | no possibility to assemble lamps

Weitere Kopfteile und Stoffauswahl/Farben siehe Register 1 | Autres têtes de lit et choix de tissus/couleurs pour coussins voir registre 1 | More headboards and choice of tissues/colours for cushions see index 1

Obag*

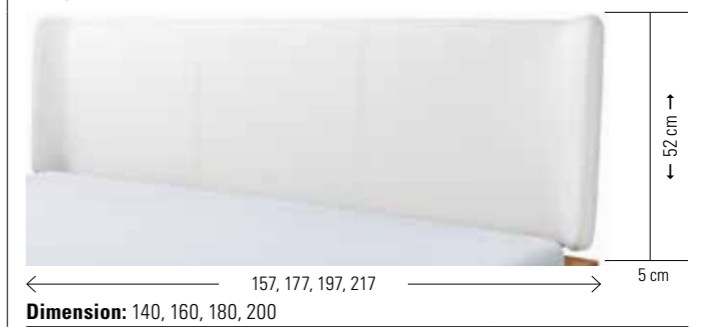

Boga

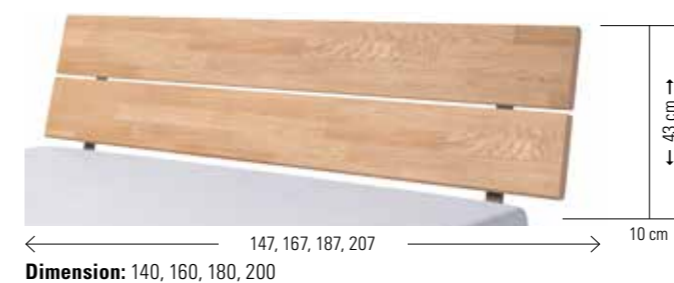
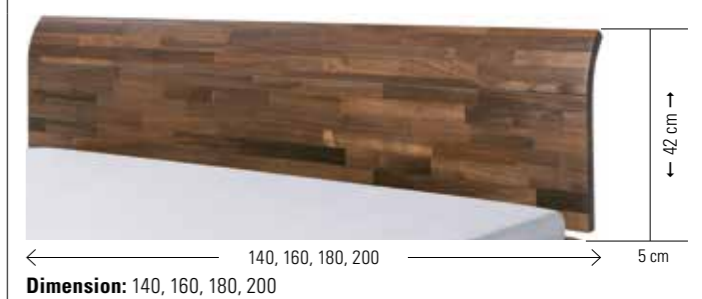
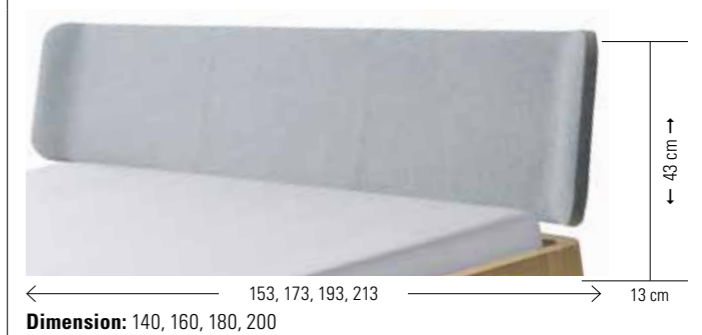

Kissen zu Kopfteilen | coussins pour têtes de lit | cushions for headboards

Arona + Duetto



Lumo + Duetto



Stoffauswahl/Farben für Kissen siehe Register 1, Seiten 6–7 | choix de tissus/couleurs pour coussins voir registre 1, pages 6–7 | choice of tissues/colours for cushions see index 1, pages 6–7

Silenzio 23 + 28

Dimension
140, 160, 180, 200
× 200, 210, 220 cm

Kopfteil **Vola**
Nachtisch **Noma** 48/43/55

Alle Polsterteile in Kitana grigio 602
Alle Holzteile in Eiche bianco, geölt

tête de lit **Vola**
table de nuit **Noma** 48/43/55

toutes les parties rembourrées en Kitana grigio 602
toutes les parties en chêne bianco, huilé

headboard **Vola**
bedside table **Noma** 48/43/55

all upholstery parts in Kitana grigio 602
all wooden parts in oak bianco, oiled



Silenzio 23 + 28

Dimension
140, 160, 180, 200
× 200, 210, 220 cm

Kopfteil **Obag**
Nachtisch **Trigo** 48/43/55
Sekretär **Aska** 120/60/85

Alle Polsterteile in Kabo calc 630
Alle Holzteile in Nussbaum, geölt

tête de lit **Obag**
table de nuit **Trigo** 48/43/55
secrétaire **Aska** 120/60/85

toutes les parties rembourrées en Kabo calc 630
toutes les parties en bois en noyer, huilé

headboard **Obag**
bedside table **Trigo** 48/43/55
bureau **Aska** 120/60/85

all upholstery parts in Kabo calc 630
all wooden parts in walnut, oiled





Pronto

Bei Bettbreite 160 + 180 cm Midtraver-move inklusive

Pour une largeur de lit de 160 + 180 cm Midtraver-move inclus
For bed width 160 + 180 cm Midtraver-move included

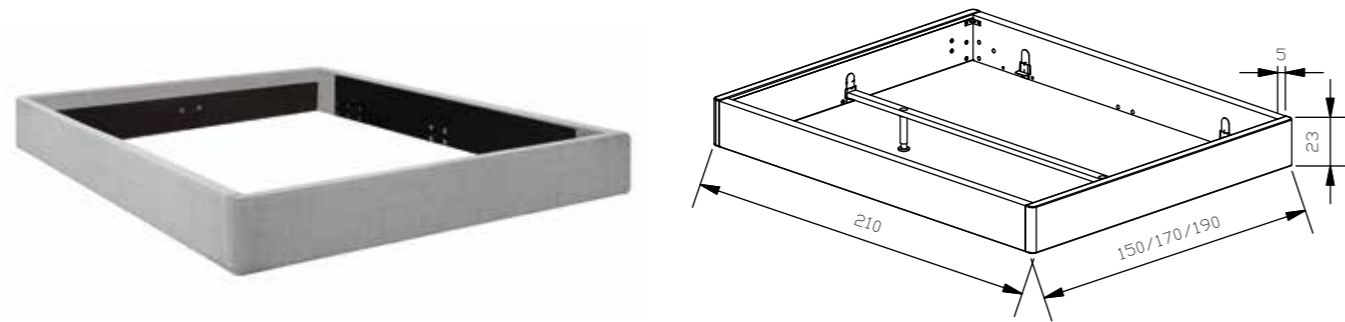

Bei allen Betten von Dream pronto ist die Einlegetiefe in 4 verschiedenen Höhen standardmässig verstellbar. Midtraver-move ist bei diesen Betten ab der Breite 160 cm inklusive.

Tous les lits Dream pronto ont une profondeur d'insertion réglable de 4 hauteurs différentes en standard. Midtraver-move est inclus avec tous les lits à partir de 160 cm de largeur.

All Dream pronto beds have an adjustable insertion depth of 4 different heights as standard. Midtraver-move is included with all these beds from 160 cm width.

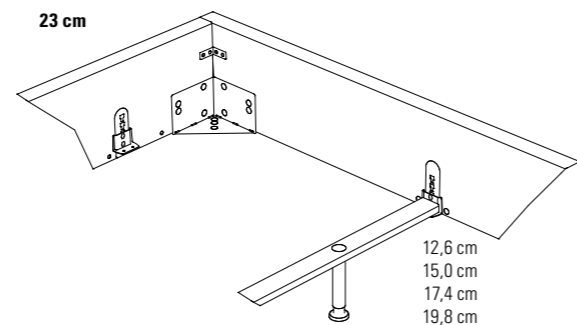

Holzfüsse und Kopfteilblenden in den Holz-ausführungen:

Pieds en bois et panneaux de tête de lit dans les finitions en bois :
Wooden feet and headboard trims in the wood versions:

Holz | bois | wood



71
Eiche bianco, geölt
Chêne bianco, huilé
Oak bianco, oiled



80
Kernbuche natur, geölt
Hêtre cœur rouge nat., huilé
Heart beech natural, oiled



85
Nussbaum, geölt
Noyer, huilé
Walnut, oiled

Lieferung ab Lager

Livraison à partir du stock
Delivery from stock



schnell
rapide | quick



zuverlässig
fiable | reliable



ab Lager
à partir du stock
from stock

Dazu passende Beimöbel siehe Register 2

Pour le mobilier auxiliaire assorti, voir le registre 2
For matching ancillary furniture, see register 2

Chest FSC Modò FSC Lina FSC anthracit, bronze, copper Circo 44/52 Nali FSC anthracit, bronze, copper

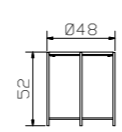
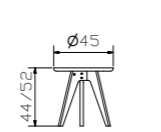
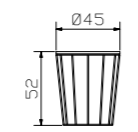
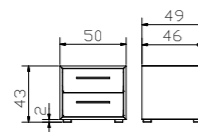
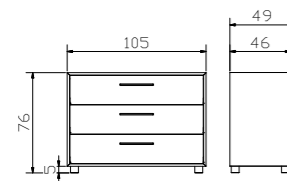

Pato

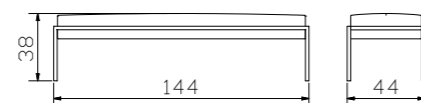

Stoffauswahl | choix de tissus | choice of fabrics

Pepe 327, 328, 335 (100 % Polyester) | (100% polyester)



327 beige



328 anthrazit



335 grey

Pepe kann chemisch gereinigt werden. Die abgebildeten Farben können von den Originalfarben und Strukturen abweichen.
Nous conseillons un nettoyage à sec pour le tissu Pepe. Les couleurs et les structures des illustrations peuvent être différentes des couleurs et des structures originales.
The fabric Pepe can be dry cleaned. The illustrated colours can be different than the original colours and structures.

Mit unserem Schnellieferservice «PRONTO» können wir eine grosse Auswahl an Betten mit Beimöbeln und alle Modelle aus Edition Pronto (Register 4), Dream pronto (Register 11) und aus dem Boxspring Katalog (Register 8) ab Lager liefern.

Die betreffenden Modelle sind in unserer Preisliste mit einem roten Punkt vor der Artikelnummer gekennzeichnet.

Notre service de livraison rapide « PRONTO » permet de livrer un large choix de lits et de meubles d'appoint et tous les modèles du édition Pronto (registre 4), Dream Pronto (registre 11) et du catalogue Boxspring (registre 8) livrables à partir du stock.

Les modèles concernés sont signalés par un point rouge devant le numéro d'article dans notre liste de prix.

With our quick delivery service «PRONTO» a huge selection of beds with side furniture and all models from Edition Pronto (index 4), Dream Pronto (index 11) and from Boxspring catalogue (index 8) can be delivered from stock.

The respective models are marked in our pricelist with a red dot in front of the article number.

Noah 20 + 25

Dimension
140, 160, 180
× 200 cm

Füsse 20, 25 cm
Nachtisch **Modo** 50/49/43

Alle Polsterteile in Pepe anthrazit 328
Alle Holzteile in Nussbaum, geölt

pieds 20, 25 cm
table de nuit **Modo** 50/49/43

toutes les parties rembourrées en Pepe anthrazit 328
toutes les parties en bois en noyer, huilé

feet 20, 25 cm
bedside table **Modo** 50/49/43

all upholstery parts in Pepe anthrazit 328
all wooden parts in walnut, oiled



Noemi 20 + 25

Dimension
140, 160, 180
× 200 cm

Füsse 20, 25 cm
Nachtisch/hocker **Rico 46** Ø 45/46

Alle Polsterteile in Pepe beige 328
Alle Holzteile in Eiche bianco, geölt

pieds 20, 25 cm
table de nuit **Rico 46** Ø 45/46

toutes les parties rembourrées en Pepe beige 328
toutes les parties en chêne bianco, huilé

feet 20, 25 cm
bedside table **Rico 46** Ø 45/46

all upholstery parts in Pepe beige 328
all wooden parts in oak bianco, oiled





MOVIE-/SOFT-/ TOP LINE



OAK PURO

Wildeiche massiv | chêne nouveau massif | solid wildoak



FACTORY LINE

Akazie massiv | acacia massif | acacia solid



WOOD LINE

Buche massiv | hêtre massif | beech solid



FINE LINE

massiv | massif | solid



NATURO

massiv | massif | solid



OAK LINE

Eiche massiv | chêne massif | solid oak



OAK WILD BORMIO/CORTINA/VINTAGE

Wildeiche massiv | chêne nouveau massif | solid wildoak



DREAM LINE

Polsterbetten | lits rembourrés | upholstered beds



FUNCTION/COMFORT KIDS&GUESTS

Achten Sie auf FSC®-certifizierte Produkte | soyez attentifs aux produits certifiés FSC® | look for FSC®-certified products



BOX Spring bed concept



LATTENROSTE & MATRATZEN

sommiers & matelas | slats & mattresses

Gesamtkatalog | catalogue
général | General catalogue

Boxspringkatalog | Catalogue
Boxspring | Box spring catalogue



siehe online Katalog | voir le cata-
logue en ligne | see online catalogue



siehe online Katalog | voir le cata-
logue en ligne | see online catalogue

